



OZ VZ ZZ

OZ AGB 90/50, Ni

OZ - obyčajný zámok
 AGB - výrobca
 90 - rozstup
 50 - hĺbka trňa
 Ni - farba niklová

OZ - obyčajný zámok
 VZ - vložkový zámok
 ZZ - záchodový zámok

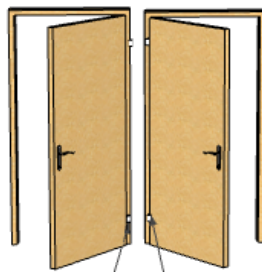

Ht - hĺbka trňa
 Hz - hĺbka zámku
 Šč - šírka čela
 Vč - výška čela

P/L - pravo/ľavý
 P, Ľ - pravý alebo ľavý

Rozety - delené štít na kľúčkách

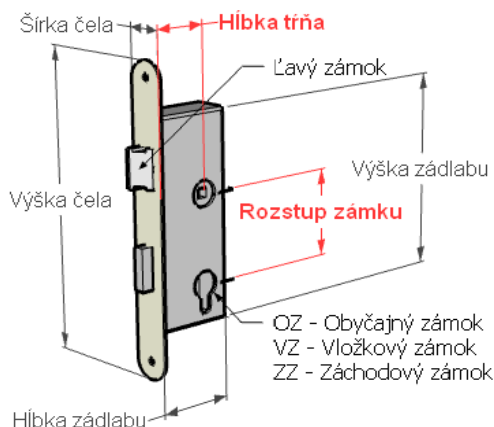

Zámky do vnútorných dverí, ekonomická trieda

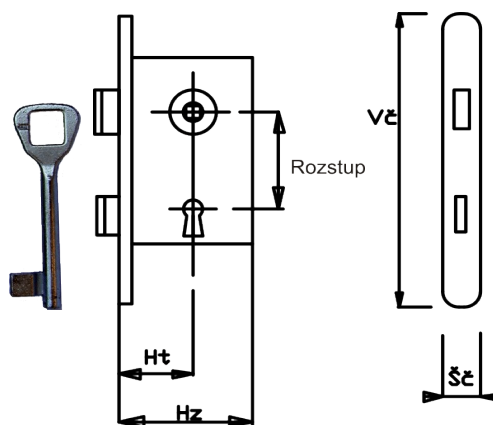
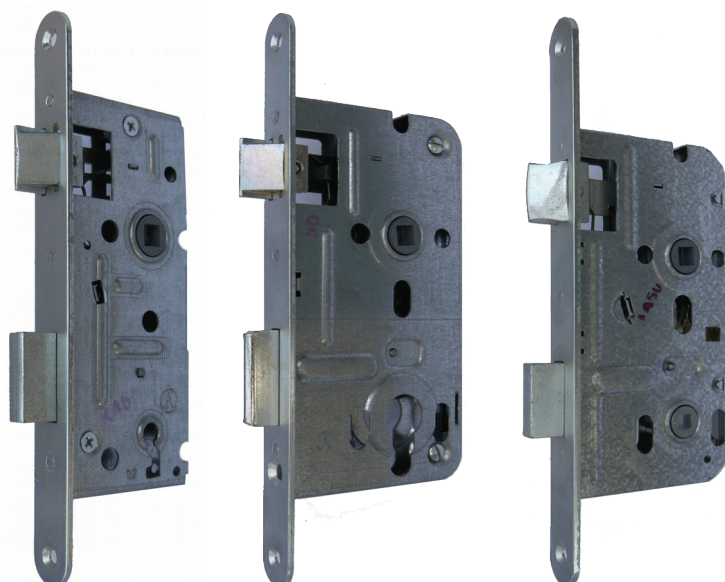

Interiérové zámky	špecifik.	farba	rozstup	Hz	Vz	Ht	Vč	Šč	□	rozety	bez DPH	s DPH
OZ TES 90/50, ZnS (K8090)	OZ, P/Ľ	zn. strieb.	90	80	170	50	230	22	8	A	4,50	5,40
VZ TES 90/50, ZnS (V8090)	VZ, P/Ľ	zn. strieb.	90	80	170	50	230	22	8	A	4,20	5,04
ZZ HOB 90/50, ZnS	ZZ, P/Ľ	zn. strieb.	90	80	170	50	230	22	8 a 6	A	8,30	9,96
OZ TES 90/45, ZnS (K6090)	OZ, P/Ľ	zn. strieb.	90	60	170	45	230	20	8	N	4,30	5,16
VZ TES 90/45, ZnS (V6090)	VZ, P/Ľ	zn. strieb.	90	60	170	45	230	20	8	N	4,20	5,04
OZ TES 90/40, ZnS (K6090/4)	OZ, P/Ľ	zn. strieb.	90	60	170	40	230	20	8	A	4,20	5,04
VZ TES 90/40, ZnS (V6090/4)	VZ, P/Ľ	zn. strieb.	90	60	170	40	230	20	8	A	4,40	5,28
ZZ HOB 90/40, ZnS (01-16 6)	ZZ, P/Ľ	zn. strieb.	90	60	170	40	230	20	8 a 6	A	8,00	9,60
OZ TES 72/55, ZnS (K8072/5)	OZ, P, Ľ	zn. strieb.	72	80	150	55	235	20	8	A	5,10	6,12
VZ TES 72/55, ZnS (V8072/5)	VZ, P, Ľ	zn. strieb.	72	80	150	55	235	20	8	A	4,90	5,88
ZZ TES 72/55, ZnS (ZZ8072/5)	ZZ, P, Ľ	zn. strieb.	72	80	150	55	235	20	8 a 6	A	4,70	5,64
OZ TES 72/50, ZnS (K8072)	OZ, P/Ľ	zn. strieb.	72	80	150	50	220	20	8	A	4,60	5,52
VZ TES 72/50, ZnS (V8072)	VZ, P/Ľ	zn. strieb.	72	80	150	50	220	20	8	A	4,20	5,04
ZZ TES 72/50, ZnS (ZZ8072)	ZZ, P/Ľ	zn. strieb.	72	80	150	50	220	20	8 a 6	A	4,10	4,92
OZ TES 72/40, ZnS (K6072)	OZ, P/Ľ	zn. strieb.	72	60	140	40	200	20	8	A	4,60	5,52
VZ TES 72/40, ZnS (V6072)	VZ, P/Ľ	zn. strieb.	72	60	140	40	200	20	8	A	4,70	5,64
ZZ TES 72/40, ZnS (ZZ6072)	ZZ, P/Ľ	zn. strieb.	72	60	140	40	200	20	8 a 6	A	4,60	5,52

Zámky a zapadacie plechy

Zmeny cenníka vyhradené. Aktualizované 08.09.2016

048 / 415 10 16, 0905 445 446, kovania.eu

Zámky do vnútorných dverí, stredná trieda

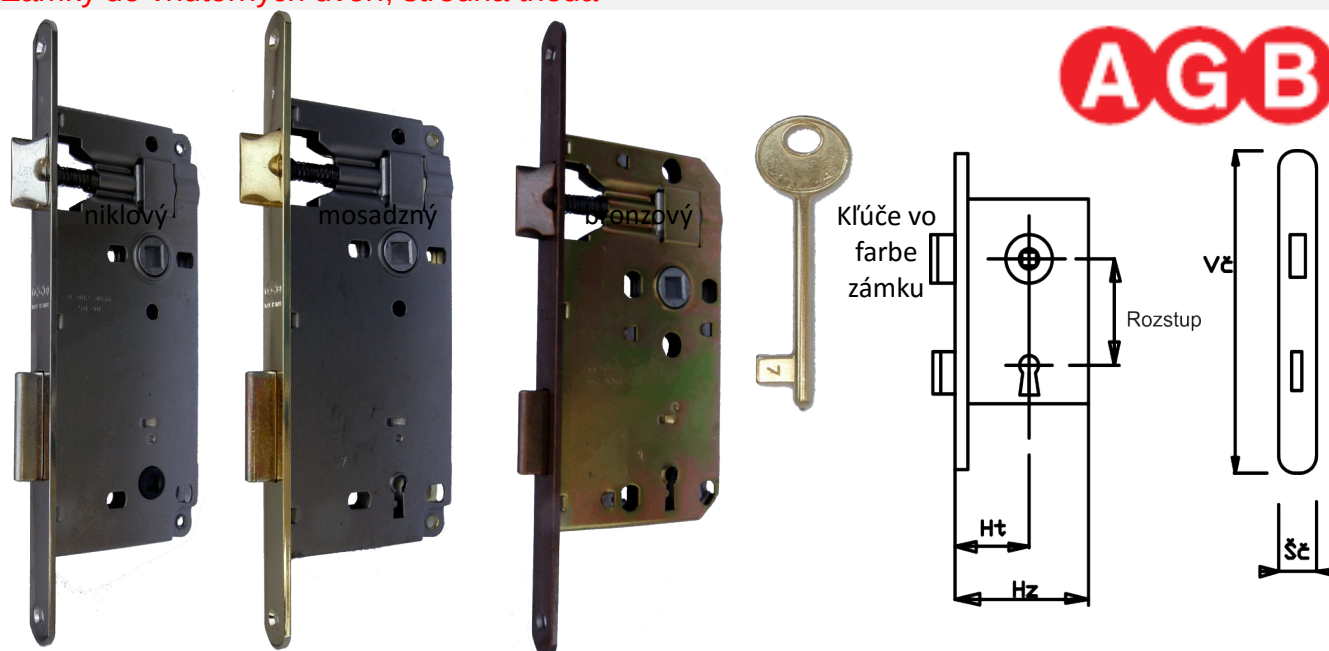

Interiérové zámky	špecifik.	farba	rozstup	H _z	V _z	H _t	V _č	Š _č	□	rozety	bez DPH	s DPH
OZ AGB 90/50, Ni	OZ, P/L	nikel lesklý	90	75	170	50	237	18	8	A	6,70	8,04
VZ AGB 90/50, Ni	VZ, P/L	nikel lesklý	90	75	170	50	237	18	9-8	A	7,70	9,24
ZZ AGB 90/50, Ni	ZZ, P/L	nikel lesklý	90	75	170	50	237	18	8 a 6	A	7,50	9,00
OZ AGB 90/50, Ms	OZ, P/L	mosadz les	90	75	170	50	237	18	8	A	5,30	6,36
VZ AGB 90/50, Ms	VZ, P/L	mosadz les	90	75	170	50	237	18	9-8	A	7,30	8,76
ZZ AGB 90/50, Ms	ZZ, P/L	mosadz les	90	75	170	50	237	18	8 a 6	A	6,00	7,20
VZ AGB 90/50, Br	VZ, P/L	bronz matr	90	75	170	50	237	18	9-8	A	7,20	8,64
ZZ AGB 90/50, Br	ZZ, P/L	bronz matr	90	75	170	50	237	18	8 a 6	A	6,70	8,04

Zámky na posuvné dvere

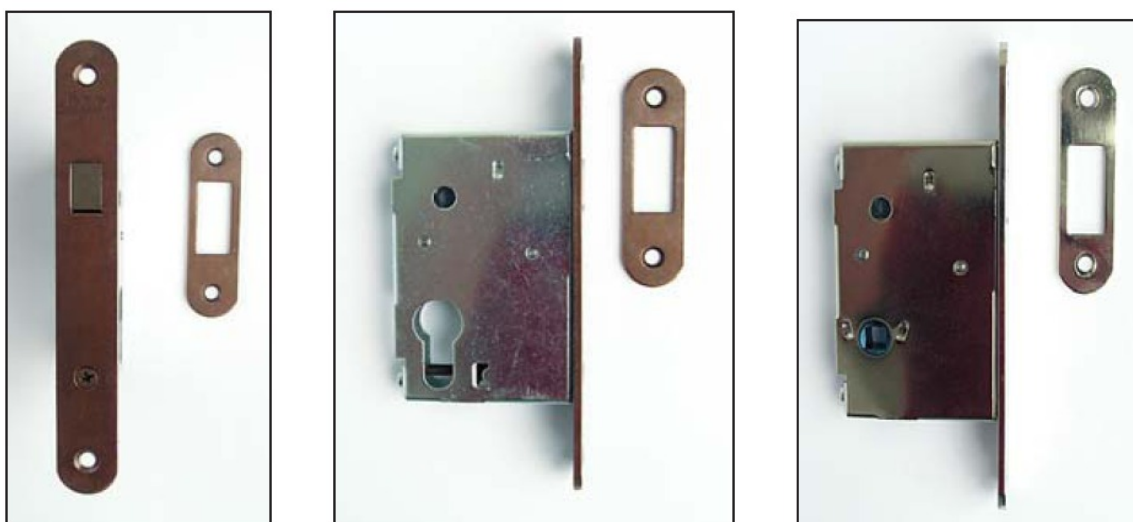

Zámky na posuvné dvere	špecifik.	farba	rozstup	H _z	V _z	H _t	V _č	Š _č	□	rozety	bez DPH	s DPH
POZ AGB 50, Ni	OZ	nikel lesklý	bez	65	100	50	17	22	bez	N	12,60	15,12
PVZ AGB 50, Ni	VZ	nikel lesklý	bez	65	100	50	17	22	bez	N	14,10	16,92
PZZ AGB 50, Ni	ZZ	nikel lesklý	bez	65	100	50	17	22	8	N	14,10	16,92
POZ AGB 50, Ms	OZ	mosadz les	bez	65	100	50	17	22	bez	N	14,10	16,92
PVZ AGB 50, Ms	VZ	mosadz les	bez	65	100	50	17	22	bez	N	12,60	15,12
PZZ AGB 50, Ms	ZZ	mosadz les	bez	65	100	50	17	22	8	N	12,60	15,12

Zámky do profilov

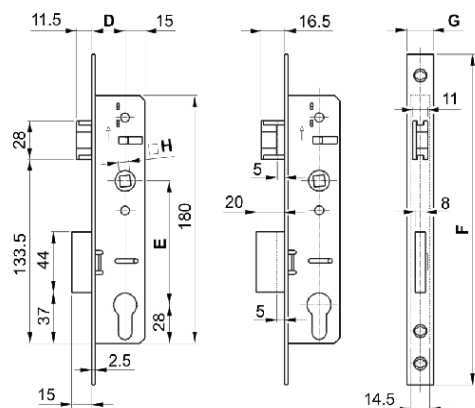

D	E	F	G	H
20/25/30/35/40/45/50	85/90/92	240/245	16/18/20/22/24	7/8/9

Typ EUROPORTAL, s jazýčkom

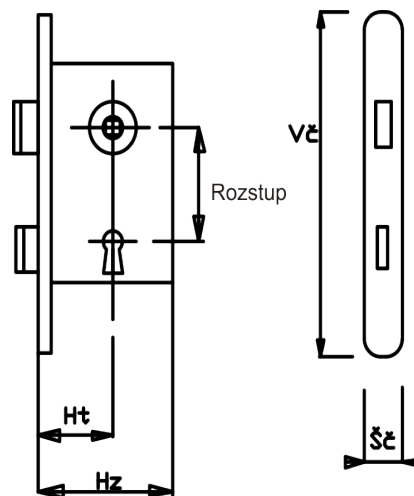

Exter. zámky s jazýčkom	špecifik.	farba	rozstup	D	D	F	G	□	rozety	bez DPH	s DPH	
			rozstup	Hz	Vz	Ht	Vč					Šč
Europortál 35, 90/20, Zn	VZ, P/L	Zn strieb.	90	35	175	20	240	22	8	N	12,00	14,40
Europortál 40, 90/25, Zn	VZ, P/L	Zn strieb.	90	40	180	25	240	22	8	N	12,00	14,40
Europortál 45, 90/30, Zn	VZ, P/L	Zn strieb.	90	45	180	30	240	22	8	N	12,00	14,40
Europortál 50, 90/35, Zn	VZ, P/L	Zn strieb.	90	50	180	35	240	22	8	N	12,00	14,40